

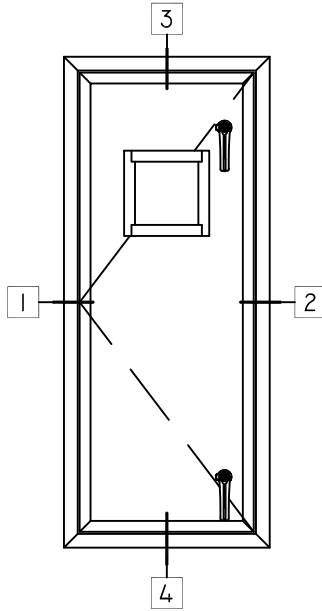

WINTECH
An Employee Owned Company

SD4200 NEGATIVE / OUTSWING



1 HINGE JAMB
SD4200 NEG

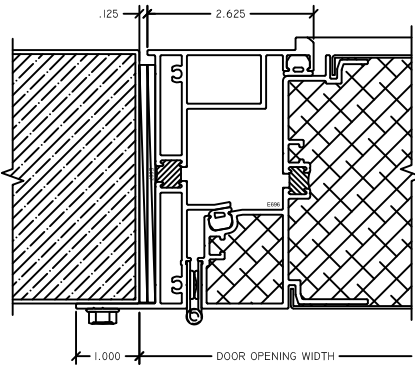

2 LOCK JAMB
SD4200 NEG

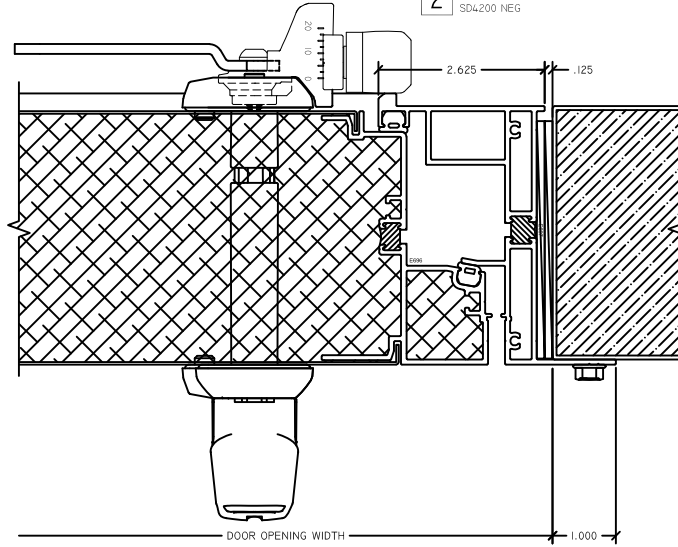

3 HEAD
SD4200 NEG

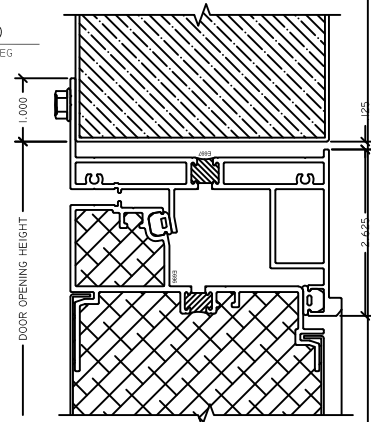

4 SILL
SD4200 NEG

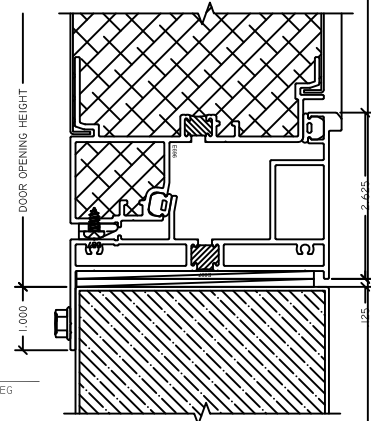

SD4200 NEGATIVE / OUTSWING TWIN WITH APPLIED MULLION

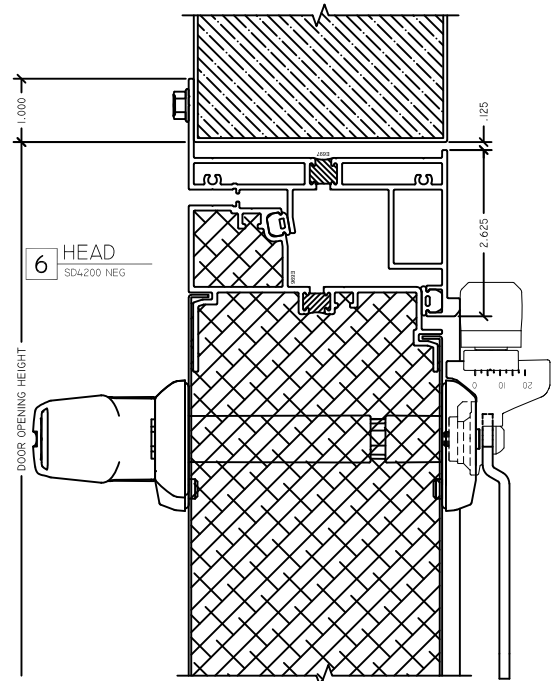
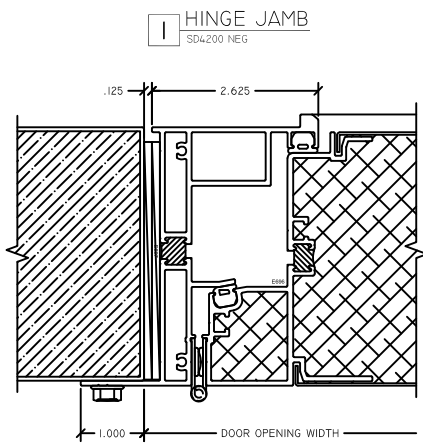
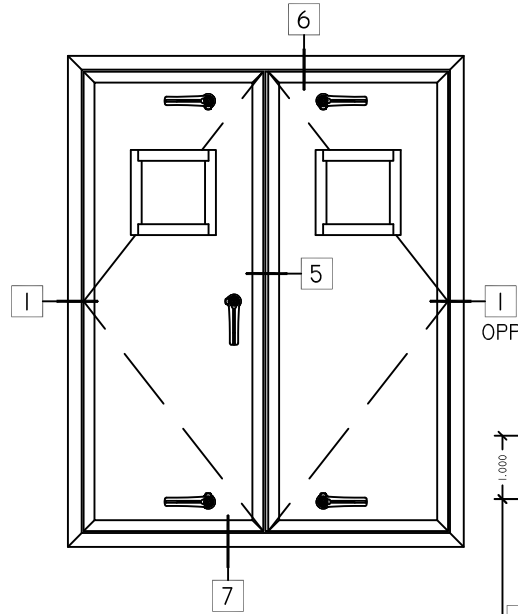

5 APPLIED MULLION
 SD4200 NEG

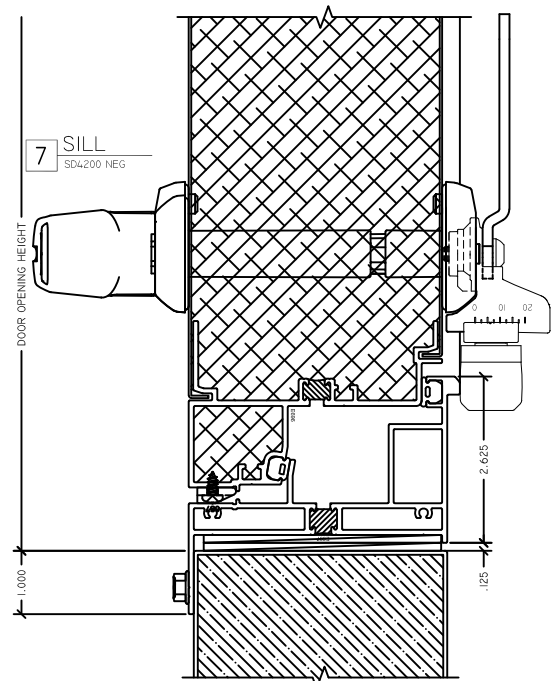
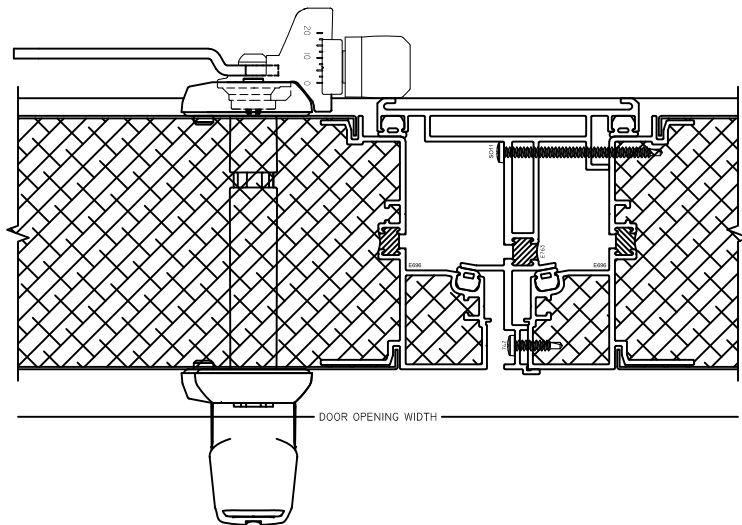

SD4200 NEGATIVE / OUTSWING TWIN WITH REMOVABLE MULLION

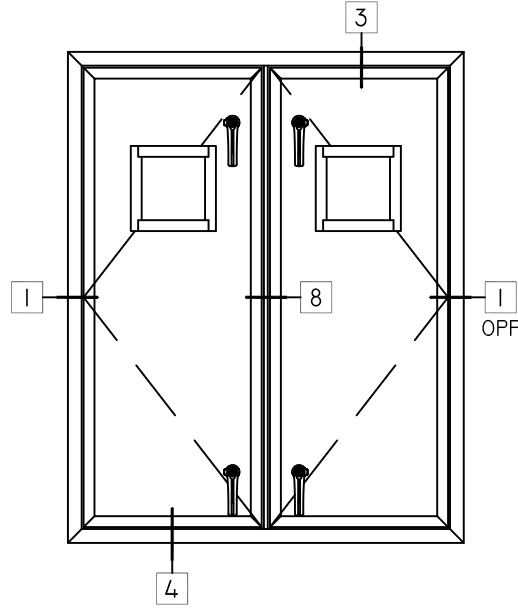

1 HINGE JAMB
 SD4200 NEG

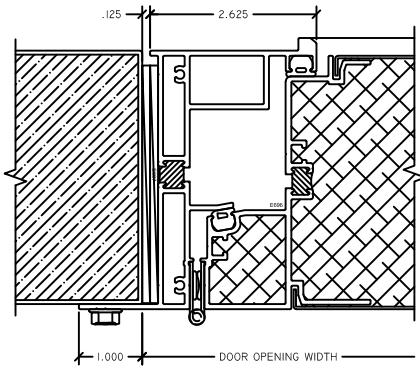

3 HEAD
 SD4200 NEG

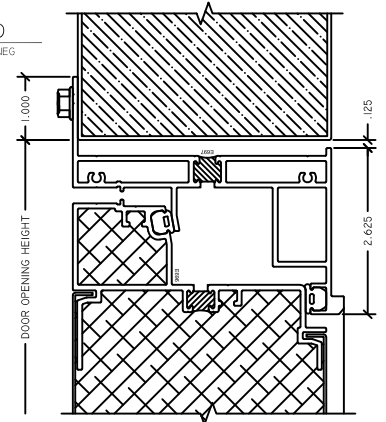

4 SILL
 SD4200 NEG

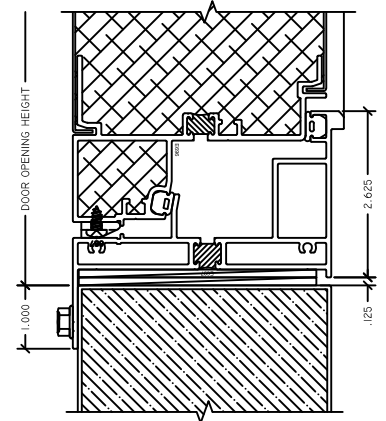

8 REMOVABLE MULLION
 SD4200 NEG

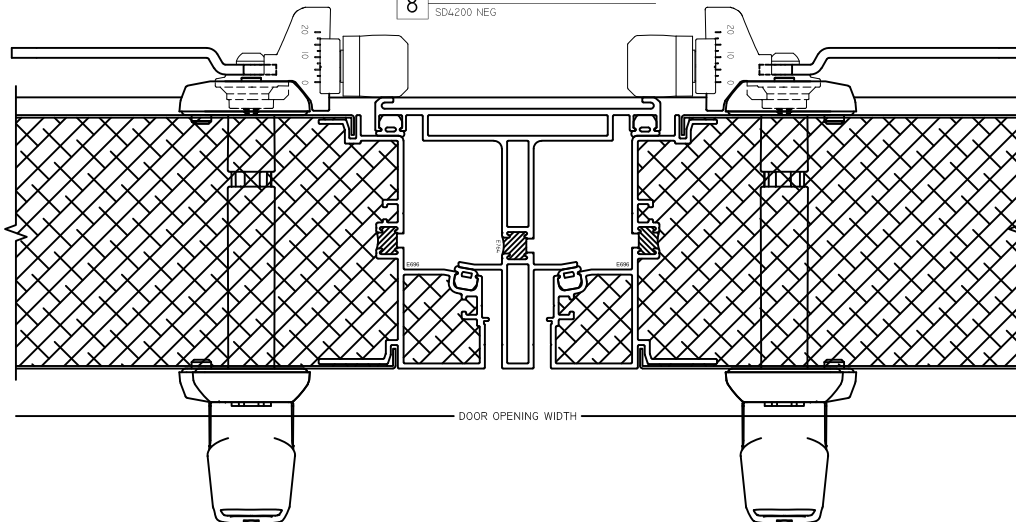

SD4200 NEGATIVE / OUTSWING INSULATE GLASS VIEWPORT

