

WINTTECH

ACCESS DOORS

SD3200 3" Non-Thermal Submittal Form

Specification of Materials Used

SD3200

NEGATIVE / OUTSWING SHOWN AT HEAD & SILL

POSITIVE / INSWING SHOWN AT JAMBS

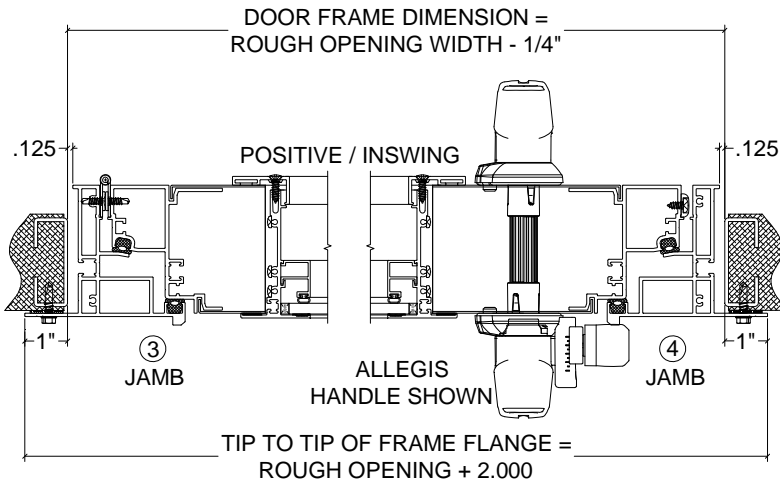
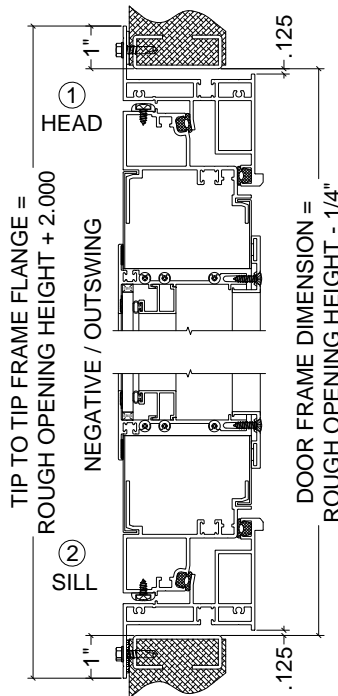
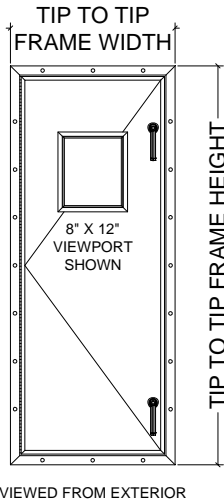

Door Construction – 45° degree mitered corners with screw spline assembly:

- Negative (Outswing)
- Positive (Inswing)

Aluminum Extrusions – Aluminum made of 6063-T5 with minimum wall thickness .080.

Double Gasket Door (2g) – Two (2) Custom Extruded EPDM Closed Cell sponge gaskets.

Foam Door Insulation – Made from BASF AUTOFROTH® 2 part Expandable Polyurethane Foam. Density of 2.40 lbs/f³, and thermal properties of K = 1.90; R_{Foam Only} = 10.5.

Door Panel Skins:

Interior Skin:

Exterior Skin:

Hinge/s - #304 Stainless Steel Piano Hinge:

- 10" Hinges
 - Continuous Hinges
 - No Hinges
- (Multiple Hinges) (Single Hinge)

Latching Handles:

View Port Glass (if applicable):

- View Port
- No View Port
- 8" x 8"
- 8" x 12"
- 12" x 12" (*Viewing Size*)
- Other: _____

Make up: _____

Note: Non-Thermal View Port Shown, Thermal View Port Available

Note and Special Instructions

- ~ Unless otherwise noted, all doors are as viewed from exterior.
- ~ Unless otherwise noted, all doors are dimensioned 1/4" less than clear or rough opening.
- ~ Hinges are opposite latching hardware, unless a plug door or fixed access panel has been supplied.
- ~ Allegis Handles shown on drawings, refer to Latching Handle section for project specific hardware.
- ~ Negative (Outswing) Head and Sill detailed. Positive (Inswing) Jambs detailed.
- ~ Door frame is weeped at sill, do not install upside down.
- ~ Refer to WinTech Installation Manual for door mounting, maintenance, and cleaning.
- ~ Details are not to scale.

Customer Information:

Project:
Customer:
Engineer:
Contractor: