



**H250 LOUVER (O.G.)
PERFORMANCE DATA:
ASTM E330 & TAS 202**

Rating	± 70 DP
Free Air	80% free air
NFPA 90 Rating	Class C (Class A available)
Structural Performance	105.0 psf
Thermally Broken	No
Frame Depth	2.438" Glazing Pocket
"R" Value	N/A
Screen Option	Bird/Insect/Blank Off

WINTeCH

P.O. BOX 480
 MONETT, MO 65708-0480

P: 417-235-7821
 F: 417-737-7140
 www.wintechinc.com

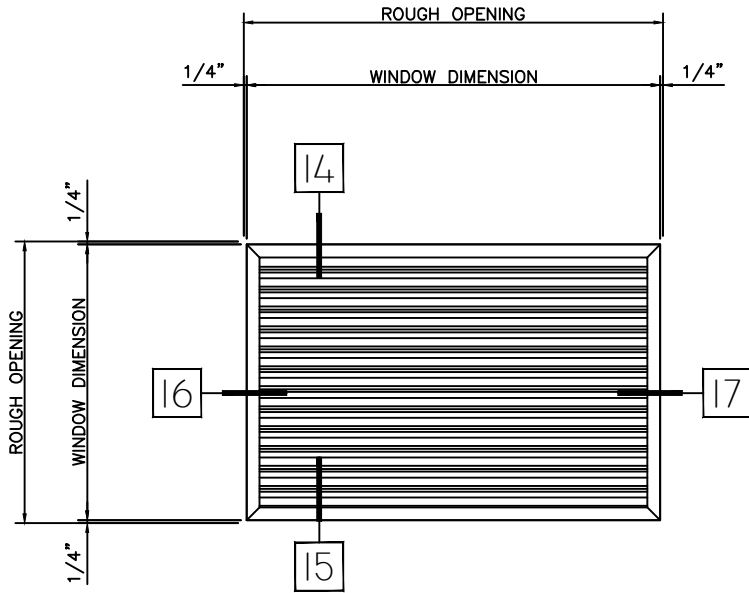

TYPE: S250	QTY:
ARCH MK:	
PRODUCT: FX OG LOUVER	

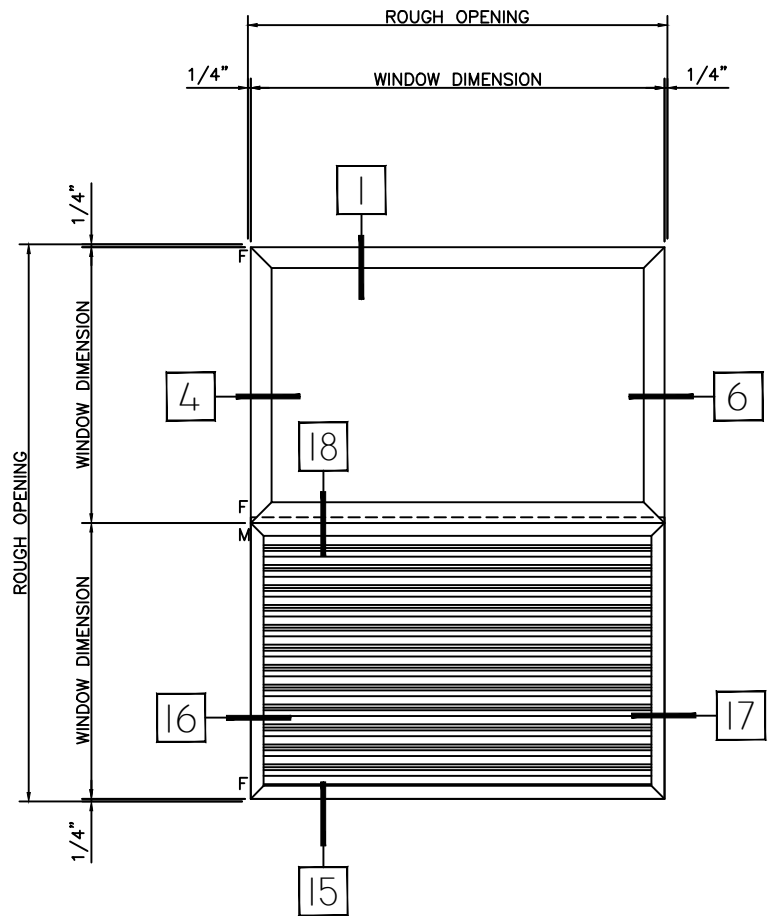

TYPE: S250	QTY:
ARCH MK:	
PRODUCT: FX IG/FX OG LOUVER	

HALF SCALE DETAILS

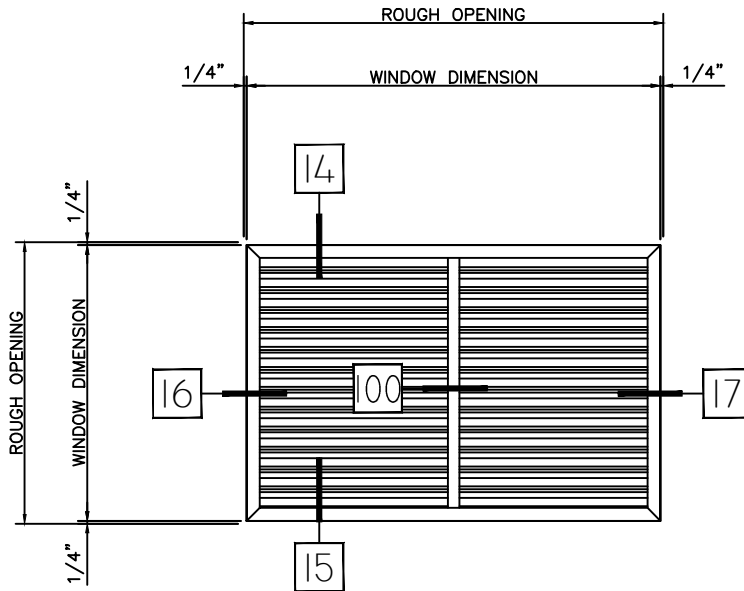

TYPE:	QTY:
S250	ARCH MK:
PRODUCT:	
FX OG LOUVER	

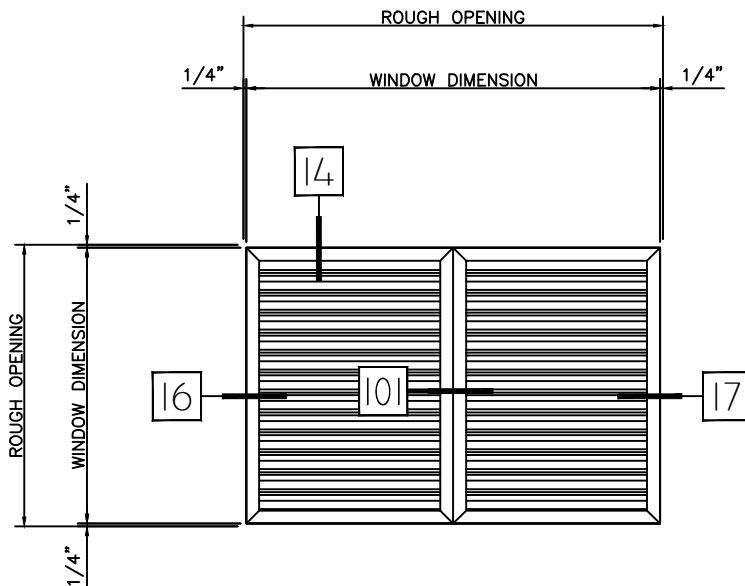

TYPE:	QTY:
S250	ARCH MK:
PRODUCT:	
FX OG LOUVER	

HALF SCALE DETAILS

14 LOUVER HEAD
OUTSIDE GLAZED

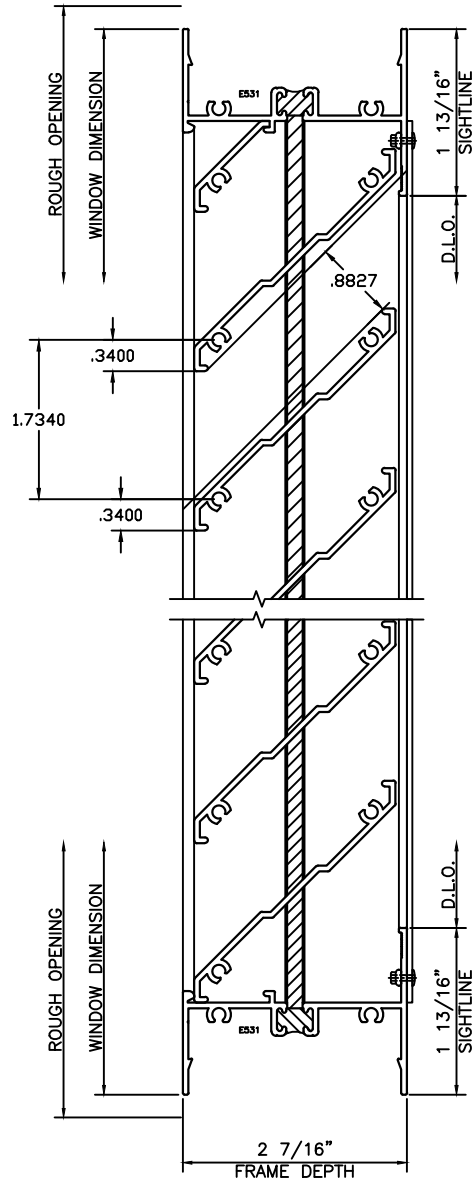

16 LOUVER JAMB
OUTSIDE GLAZED

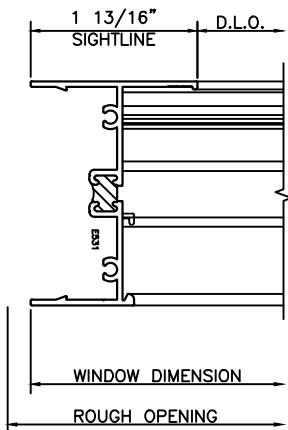

17 LOUVER JAMB
OUTSIDE GLAZED

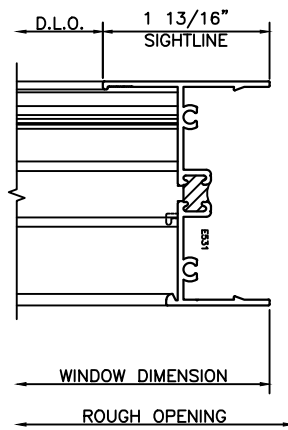

15 LOUVER SILL
OUTSIDE GLAZED

HALF SCALE DETAILS

