

**3210 SLIDER PERFORMANCE DATA:
AAMA/WDMA/CSA 101/I.S.2/A440-08
AAMA/WDMA/CSA 101/I.S.2/A440-11**

Rating	*CW-PG50-HS
Air Infiltration	<0.15 cfm/ft @ 1.57 psf
Water Resistance	**0 leakage at 7.5 lb
Structural Performance	+/- 75.19 psf
Thermally Broken	Yes
Frame Depth	3-1/4"
Infill Options	Maximum 1"
*Optional Performance	CW-PG65-HS
** Optional Water	0 leakage at 10.0 lb

WINTeCH

P.O. BOX 480
MONETT, MO 65708-0480

P: 417-235-7821
F: 417-737-7140
www.wintechinc.com

3210 HORIZONTAL SLIDER

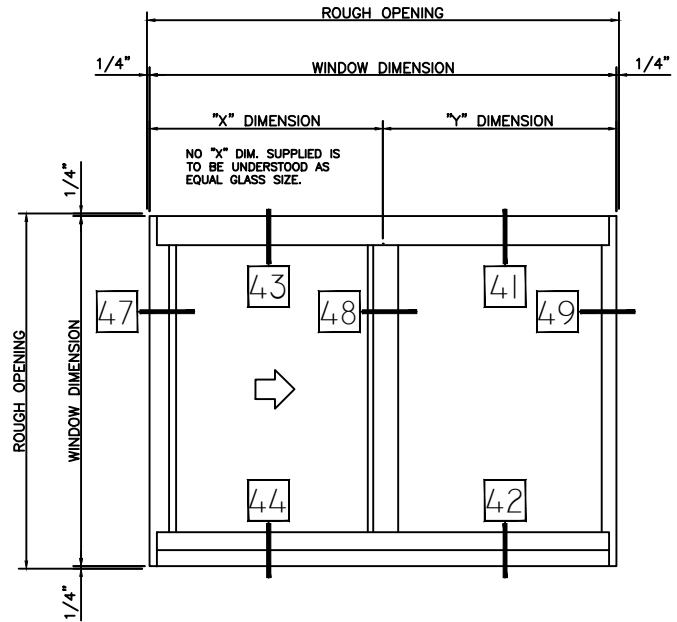
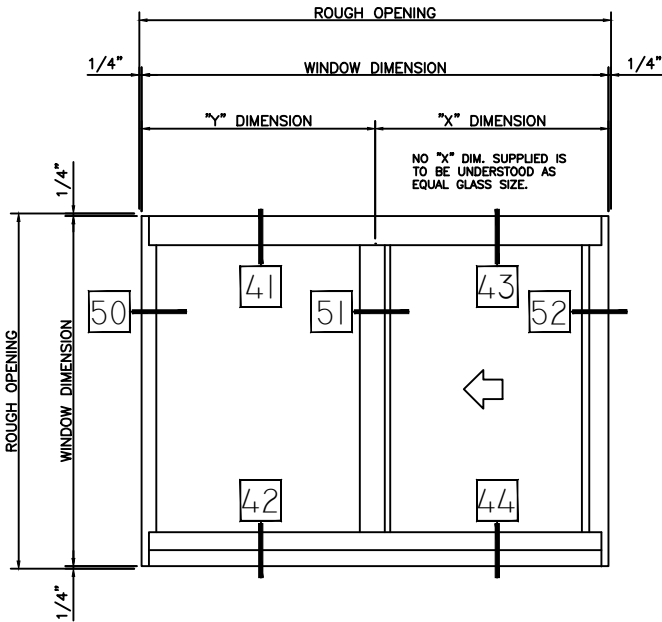

TYPE:	QTY:
OX	ARCH MK:
PRODUCT:	
3210 SLIDER	
7 LB SILL	

TYPE:	QTY:
XO	ARCH MK:
PRODUCT:	
3210 SLIDER	
7 LB SILL	

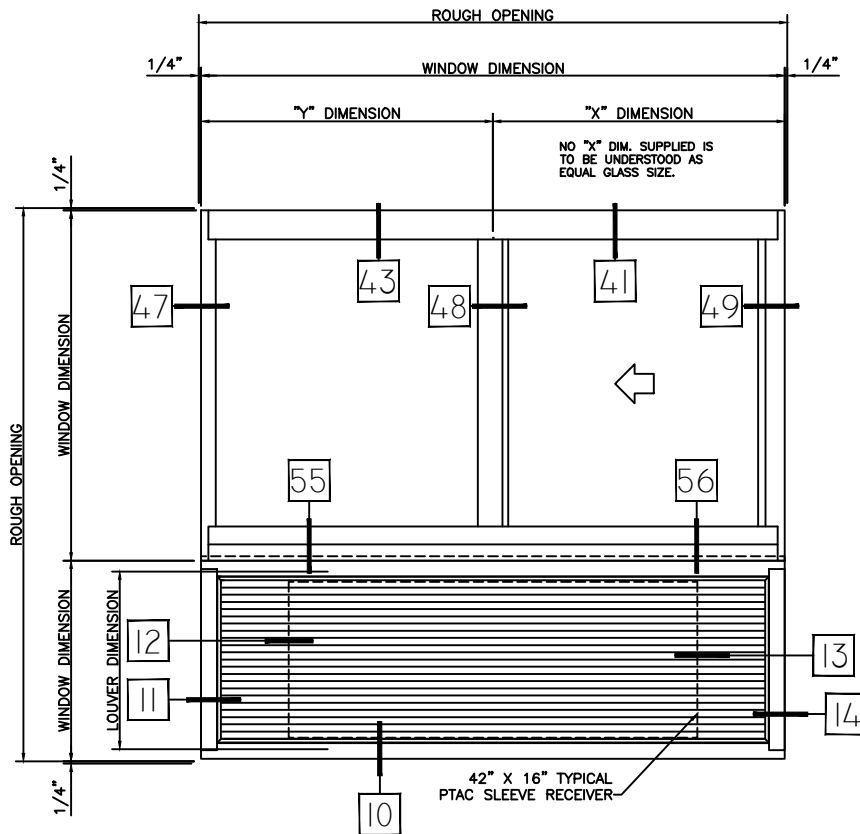

TYPE:	QTY:
OX/LOUVER	ARCH MK:
PRODUCT:	
3210 SLIDER	
FXD PTAC LOUVER	

HALF SCALE DETAILS

WINTeCH

P.O. BOX 480
MONETT, MO 65708-0480

P: 417-235-7821
F: 417-737-7140
www.wintechinc.com

3210 HORIZONTAL SLIDER

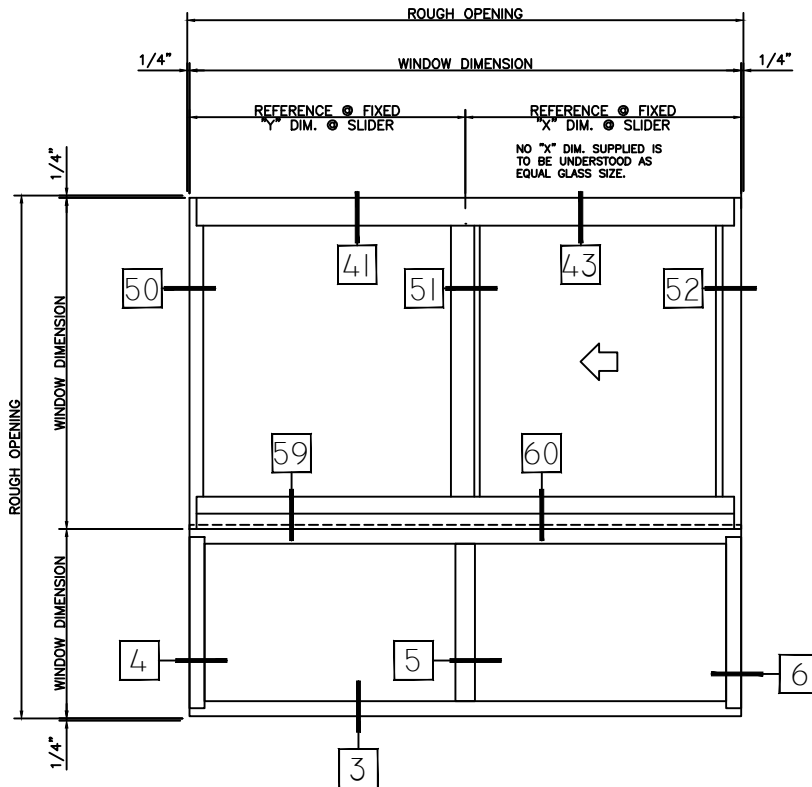

TYPE:	QTY:
OX/FX-FX	ARCH MK:
PRODUCT:	
3210 SLIDER	
3250 FXD-FXD	

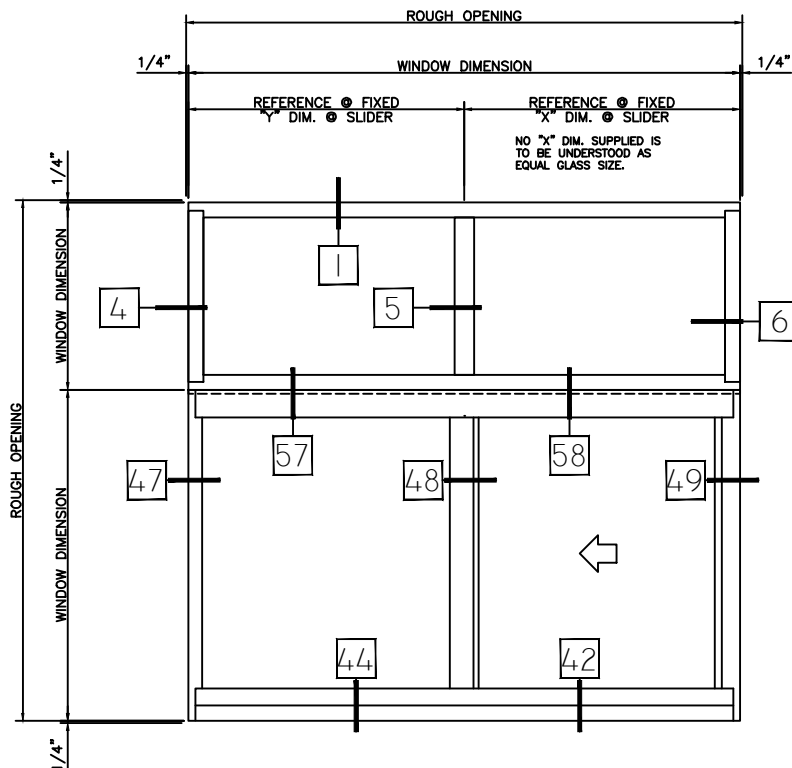

TYPE:	QTY:
FX-FX/OX	ARCH MK:
PRODUCT:	
3250 FXD-FXD	
3210 SLIDER	

HALF SCALE DETAILS

WINTeCH

P.O. BOX 480
MONETT, MO 65708-0480

P: 417-235-7821
F: 417-737-7140
www.wintechinc.com

3210 HORIZONTAL SLIDER

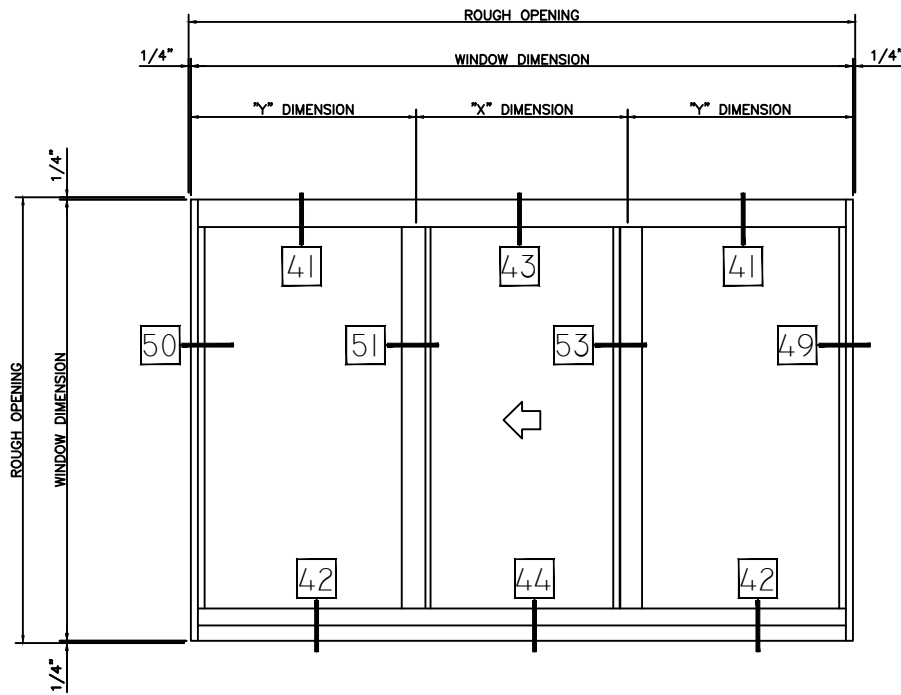

TYPE:	QTY:
OXOL	ARCH MK:
PRODUCT:	
3210 SLIDER	
7 LB SILL	

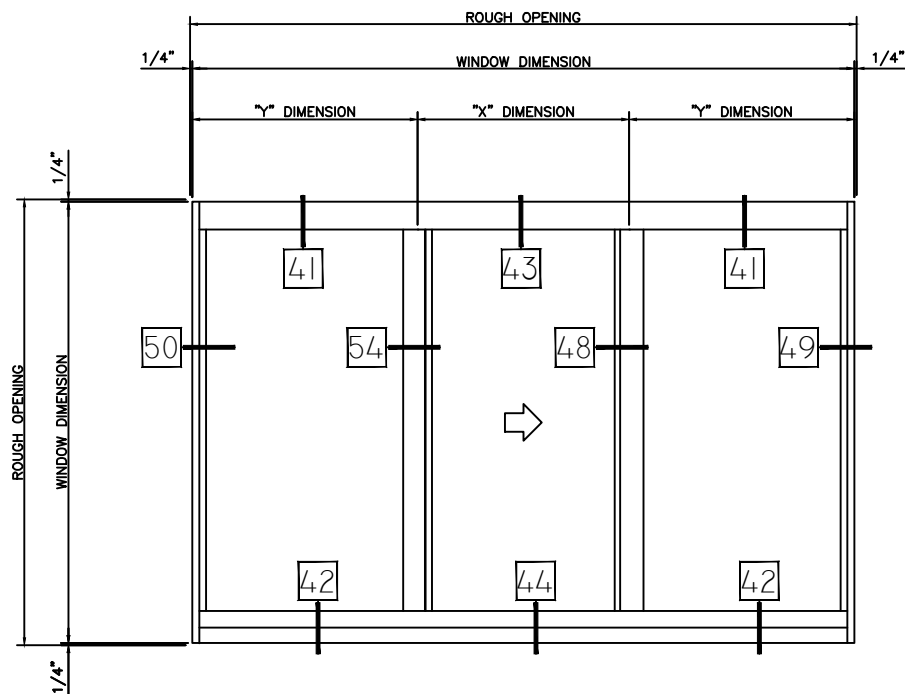

TYPE:	QTY:
OXOR	ARCH MK:
PRODUCT:	
3210 SLIDER	
7 LB SILL	

HALF SCALE DETAILS

WINTeCH

P.O. BOX 480
MONETT, MO 65708-0480

P: 417-235-7821
F: 417-737-7140
www.wintechinc.com

3210 HORIZONTAL SLIDER

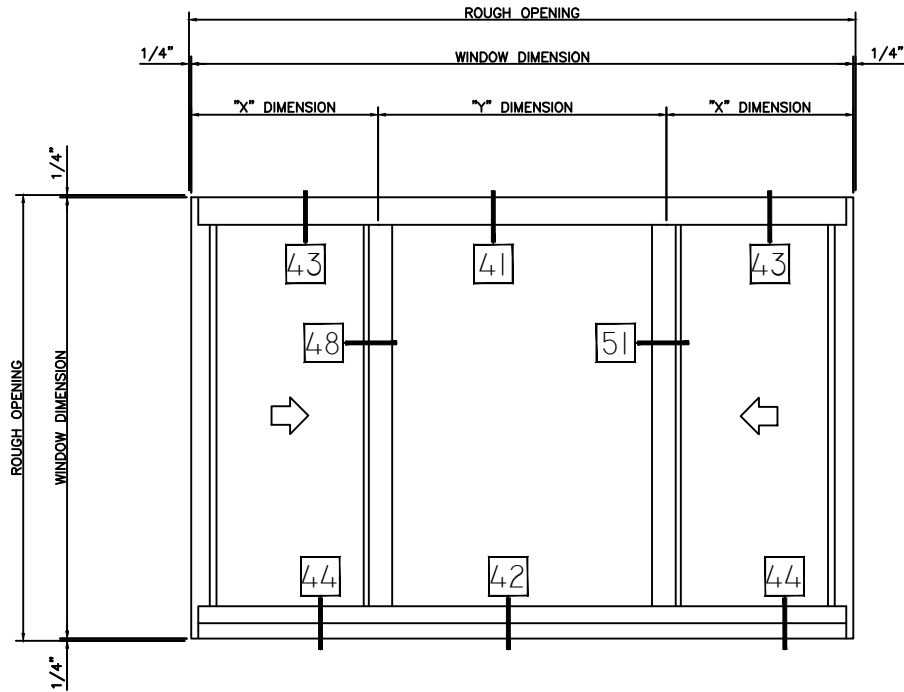

TYPE:	QTY:
XOX	ARCH MKC:
PRODUCT:	3210 SLIDER
	7 LB SILL

HALF SCALE DETAILS

WINTech

P.O. BOX 480
MONETT, MO 65708-0480

P: 417-235-7821
F: 417-737-7140
www.wintechinc.com

3210 HORIZONTAL SLIDER

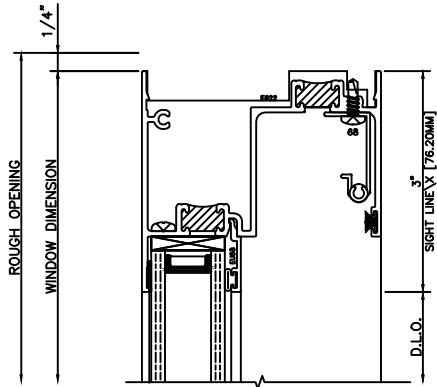

41 FIXED HEAD
3210 SLIDER

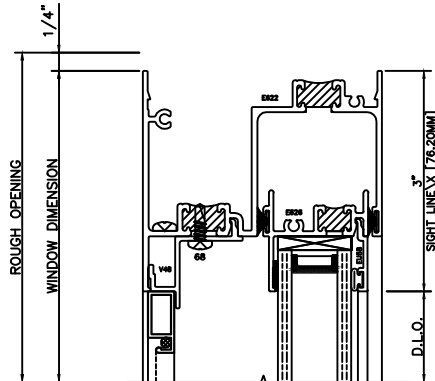

43 SASH HEAD
3210 SLIDER

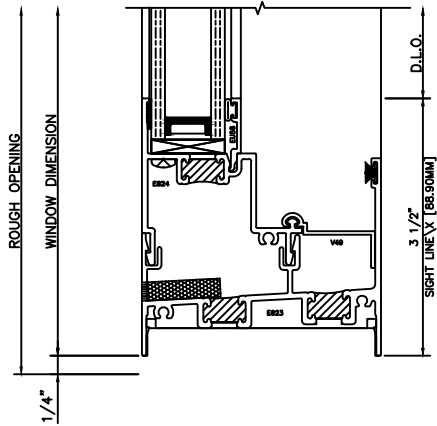

42 FIXED SILL
3210 SLIDER-7LB SILL

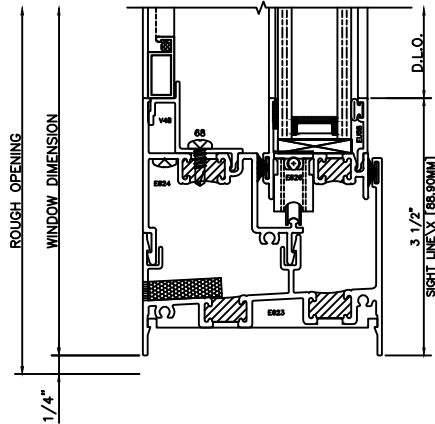

44 SASH SILL
3210 SLIDER-7LB SILL

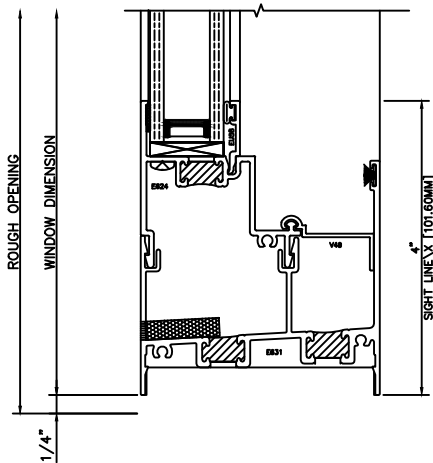

45 FIXED SILL
3210 SLIDER-10 LB SILL

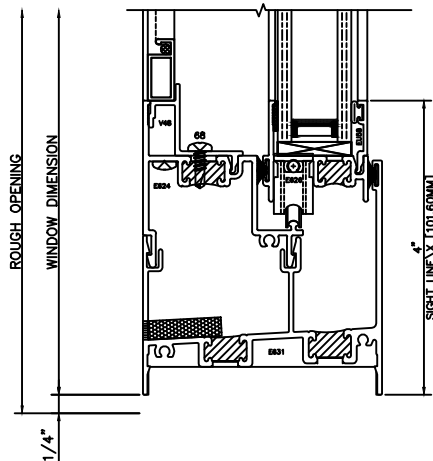

46 SASH SILL
3210 SLIDER-10 LB SILL

HALF SCALE DETAILS

WINTeCH

P.O. BOX 480
MONETT, MO 65708-0480

P: 417-235-7821
F: 417-737-7140
www.wintechinc.com

3210 HORIZONTAL SLIDER

47 SASH JAMB
3210 SLIDER

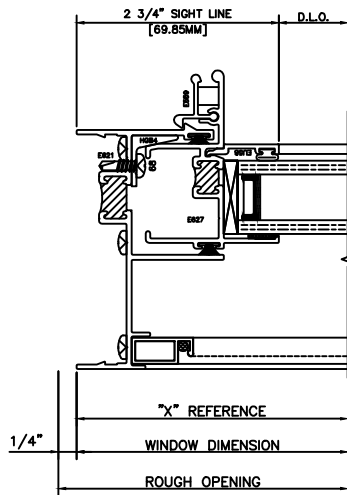

48 MTG RAIL
3210 SLIDER
OX

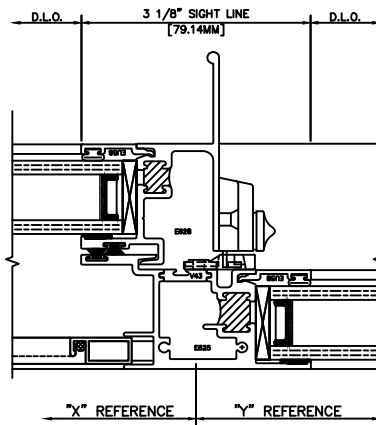

49 FIXED JAMB
3210 SLIDER

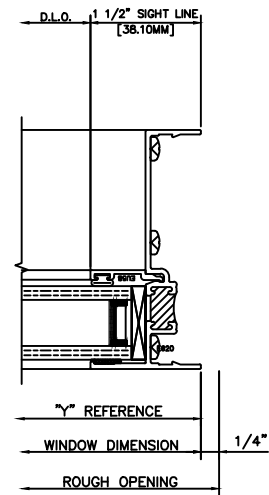

50 FIXED JAMB
3210 SLIDER

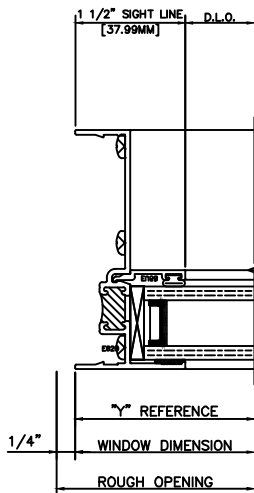

51 MTG RAIL
3210 SLIDER
XO

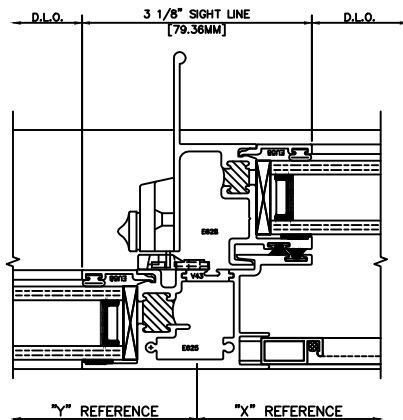

52 SASH JAMB
3210 SLIDER

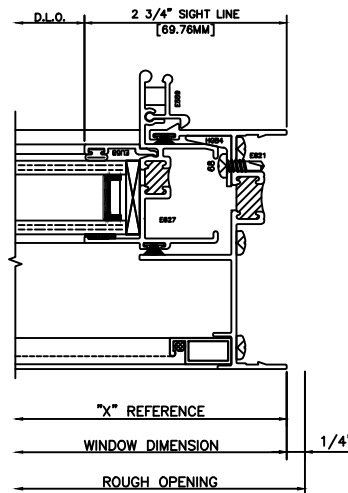

HALF SCALE DETAILS

WINTeCH

P.O. BOX 480
MONETT, MO 65708-0480

P: 417-235-7821
F: 417-737-7140
www.wintechinc.com

3210 HORIZONTAL SLIDER

53 MTG RAIL
3210 SLIDER
OXOR

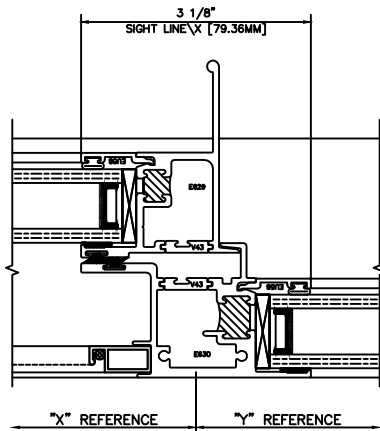

54 MTG RAIL
3210 SLIDER
OXOL

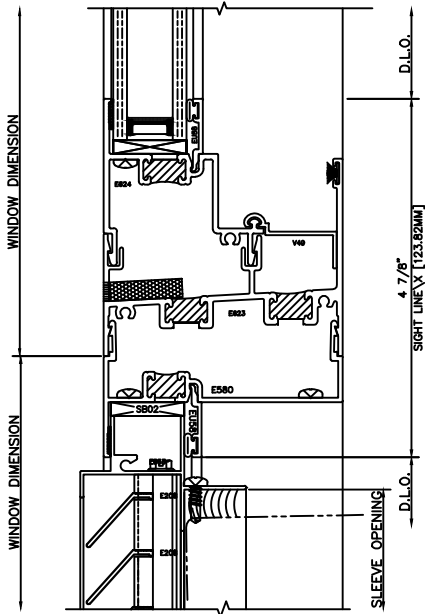
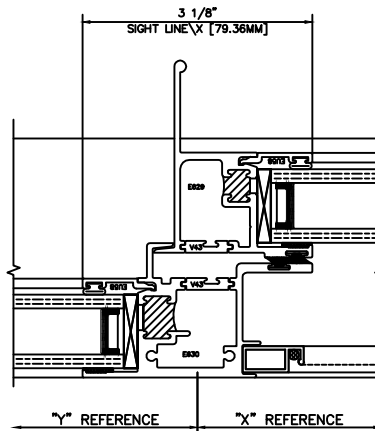

55 FIXED SILL
3210 SLIDER-7LB SILL
3250 FRONT SET
PTAC LOUVER

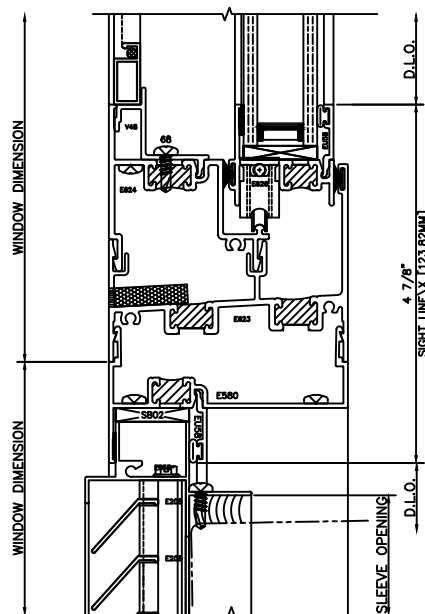

56 SASH SILL
3210 SLIDER-7LB SILL
3250 FRONT SET
PTAC LOUVER

HALF SCALE DETAILS

WINTECH

P.O. BOX 480
MONETT, MO 65708-0480

P: 417-235-7821
F: 417-737-7140
www.wintechinc.com

3210 HORIZONTAL SLIDER

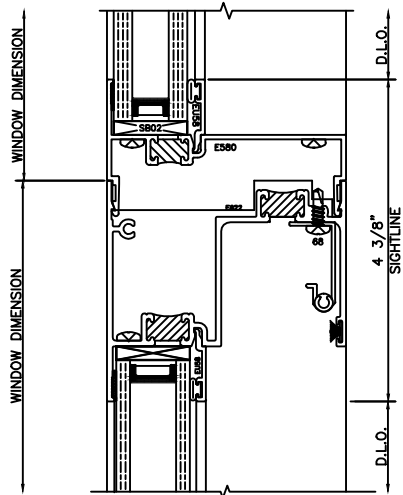

57 STACK
3250 FRONT SET FIXED
3210 SLIDER FIXED HEAD

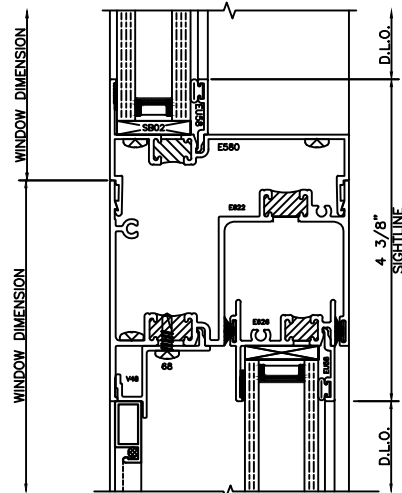

58 STACK
3250 FRONT SET FIXED
3210 SLIDER SASH HEAD

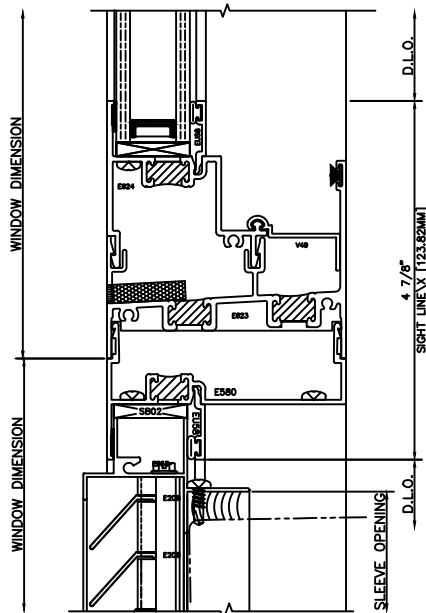

59 FIXED SILL
3210 SLIDER-7LB SILL
3250 FRONT SET
PTAC LOUVER

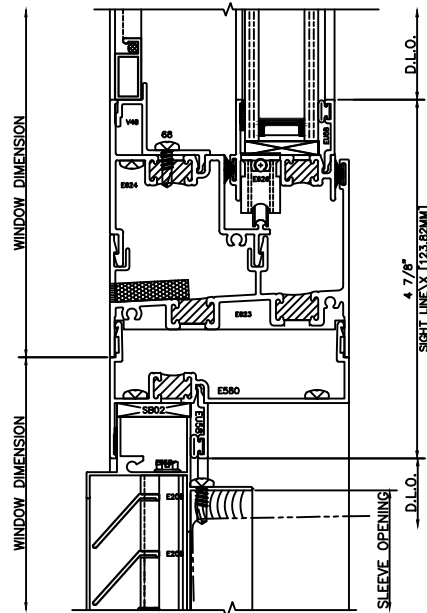

60 SASH SILL
3210 SLIDER-7LB SILL
3250 FRONT SET
PTAC LOUVER

HALF SCALE DETAILS