

**S250 PROJECT OUT CASEMENT PERFORMANCE DATA:  
AAMA/WDMA/CSA 101/I.S.2/A440-08  
AAMA/WDMA/CSA 101/I.S.2/A440-11**

<b>Rating</b>	<b>CW-PG60-C</b>
<b>Air Infiltration</b>	<b>&lt;0.15 cfm/ft @ 1.57 psf</b>
<b>Water Resistance</b>	<b>**0 leakage at 12.0 lb</b>
<b>Structural Performance</b>	<b>+/- 90.00 psf</b>
<b>Thermally Broken</b>	<b>Yes</b>
<b>Frame Depth</b>	<b>2-1/2"</b>
<b>Infill Options</b>	<b>Maximum 1"</b>

**\*\* Optional Water                      0 leakage at 15.0 lb**

# WINTeCH

P.O. BOX 480  
 MONETT, MO 65708-0480

P: 417-235-7821  
 F: 417-737-7140  
 www.wintechinc.com

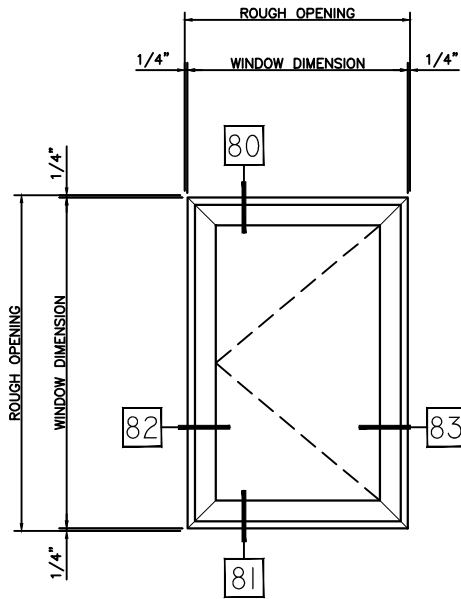

TYPE:	QTY:
S250	ARCH MKG:
PRODUCT:	
COL	

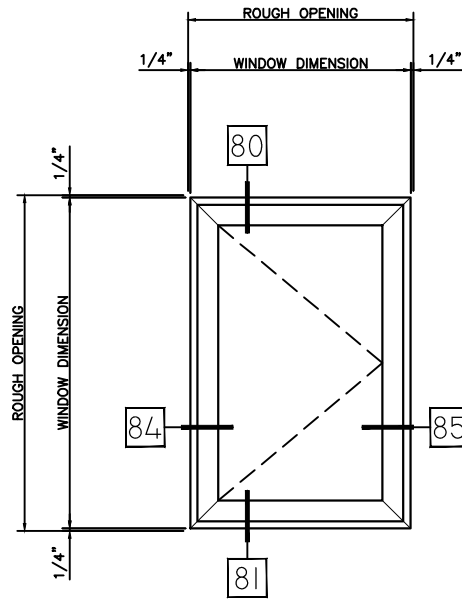

TYPE:	QTY:
S250	ARCH MKG:
PRODUCT:	
COR	

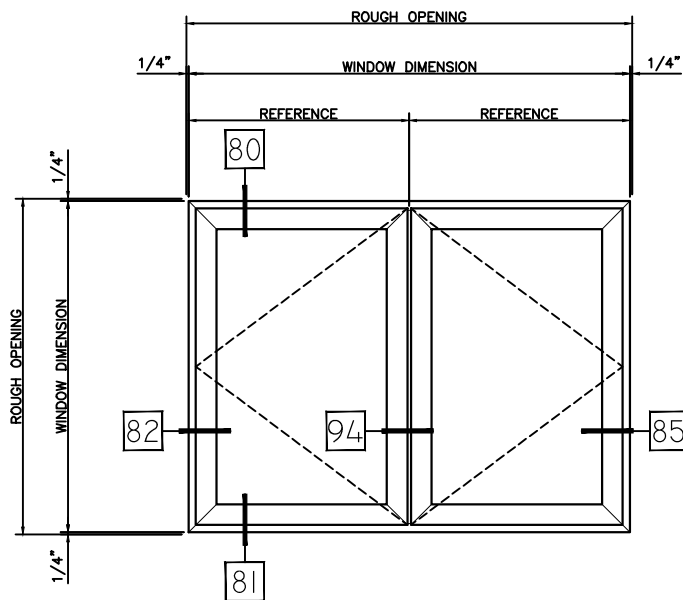

TYPE:	QTY:
S250	ARCH MKG:
PRODUCT:	
COL-COR	

HALF SCALE DETAILS

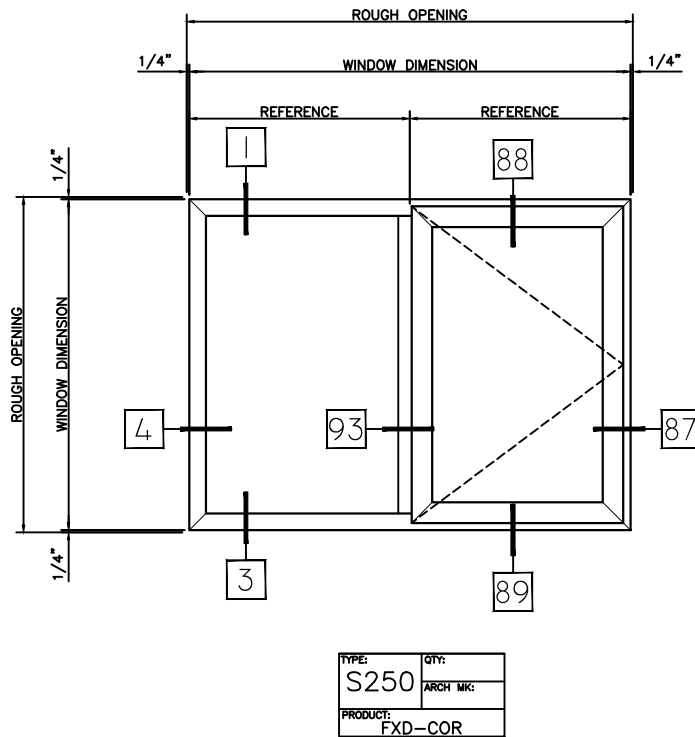
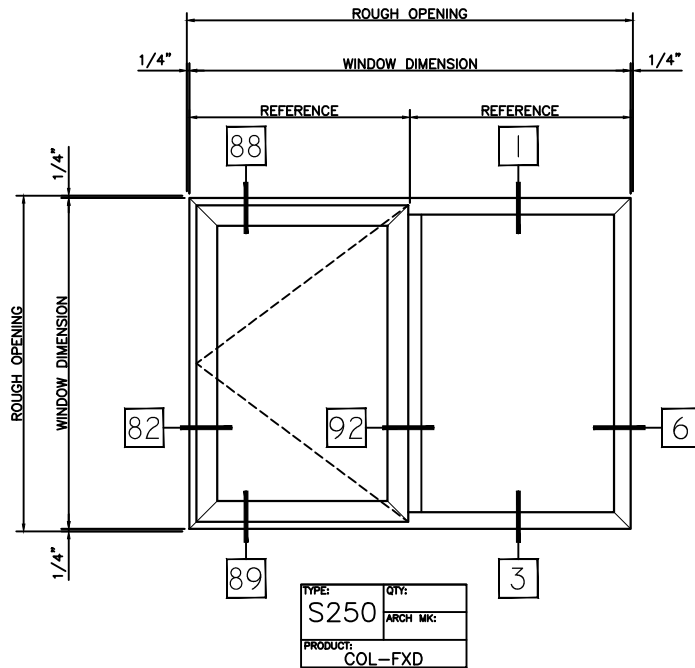

HALF SCALE DETAILS

# WINTECH

P.O. BOX 480  
 MONETT, MO 65708-0480

P: 417-235-7821  
 F: 417-737-7140  
 www.wintechinc.com

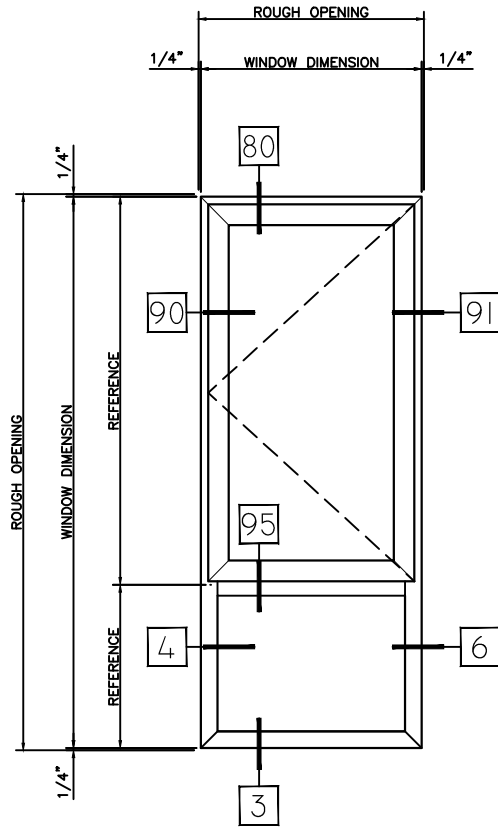

TYPE:	QTY:
S250	ARCH MK:
PRODUCT:	
COL/FXD	

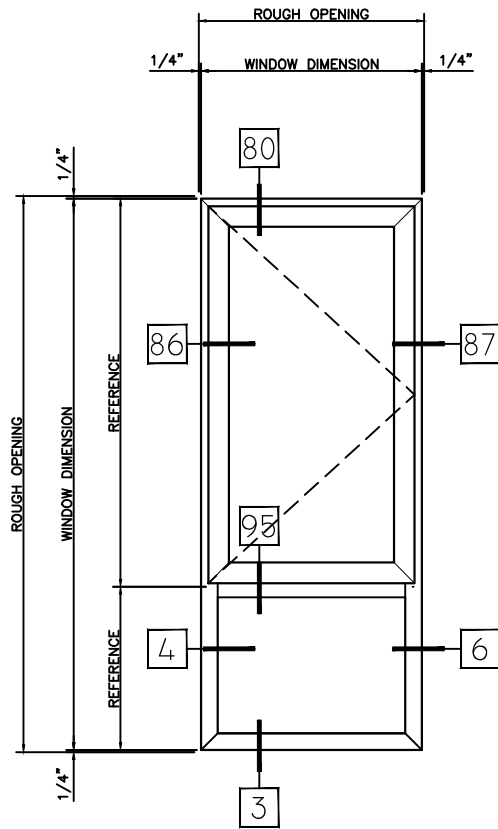

TYPE:	QTY:
S250	ARCH MK:
PRODUCT:	
COR/FXD	

HALF SCALE DETAILS

# WINTECH

P.O. BOX 480  
 MONETT, MO 65708-0480

P: 417-235-7821  
 F: 417-737-7140  
 www.wintechinc.com

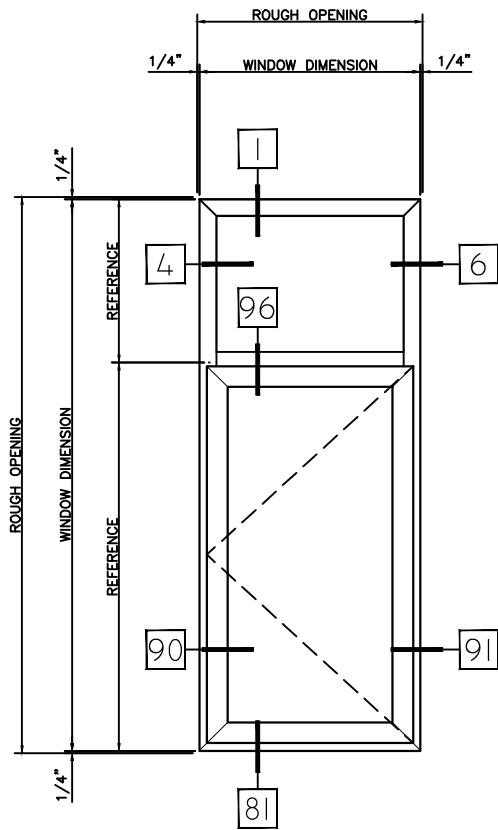

TYPE:	QTY:
S250	ARCH MK:
PRODUCT:	
FXD/COL	

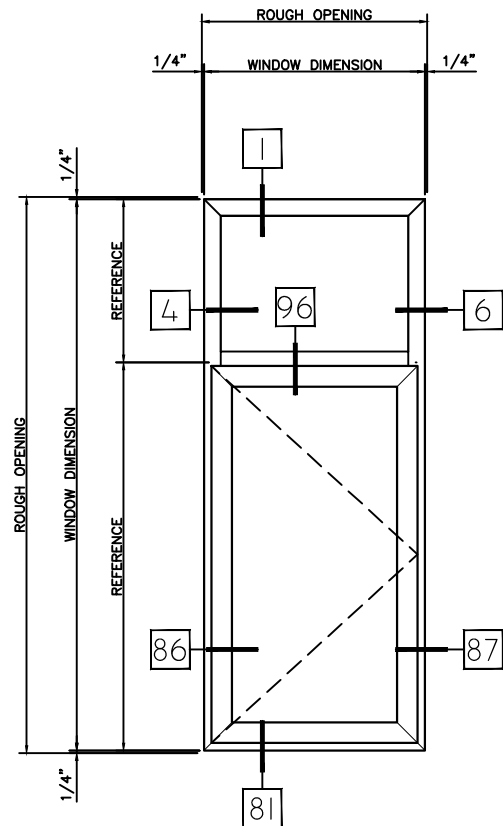

TYPE:	QTY:
S250	ARCH MK:
PRODUCT:	
FXD/COR	

HALF SCALE DETAILS

# WINTech

P.O. BOX 480  
 MONETT, MO 65708-0480

P: 417-235-7821  
 F: 417-737-7140  
 www.wintechinc.com

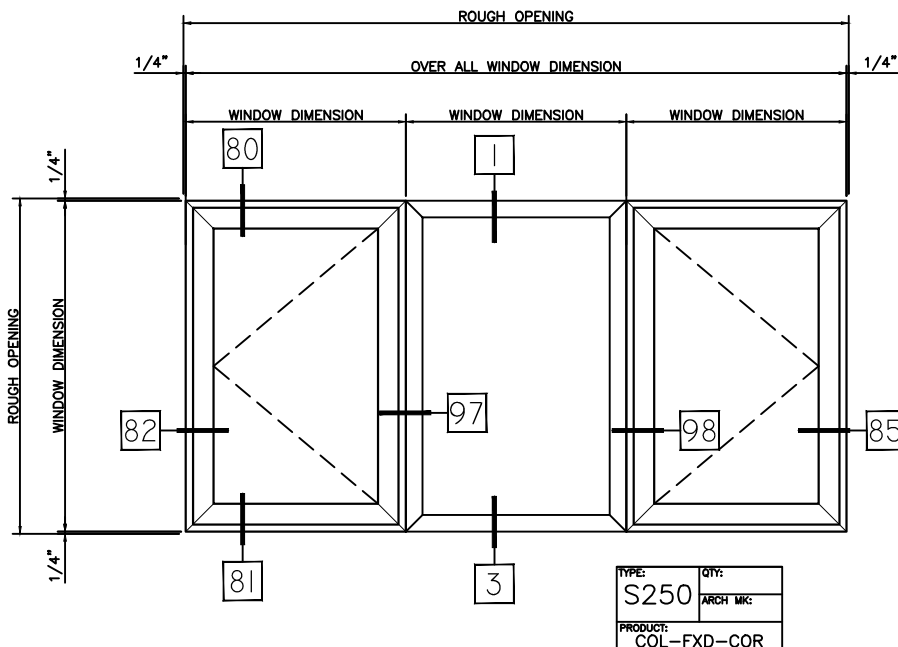
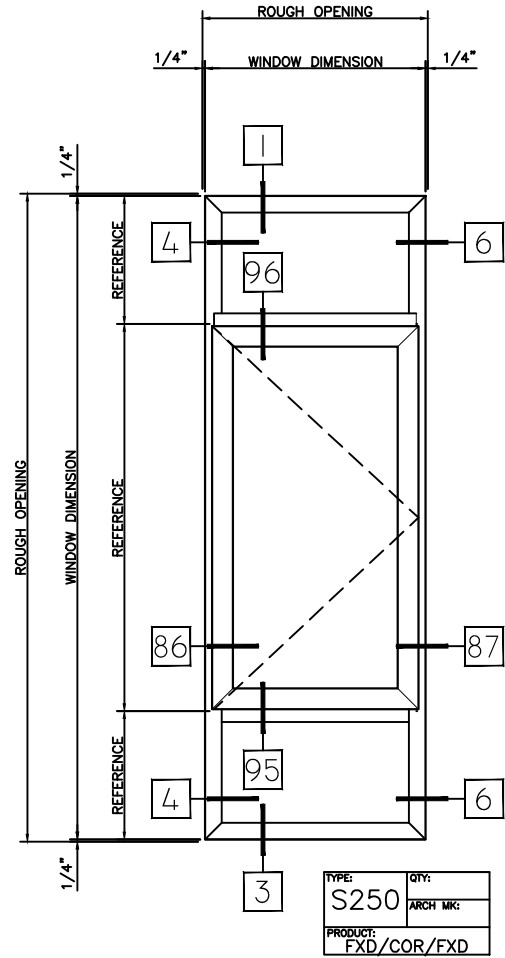
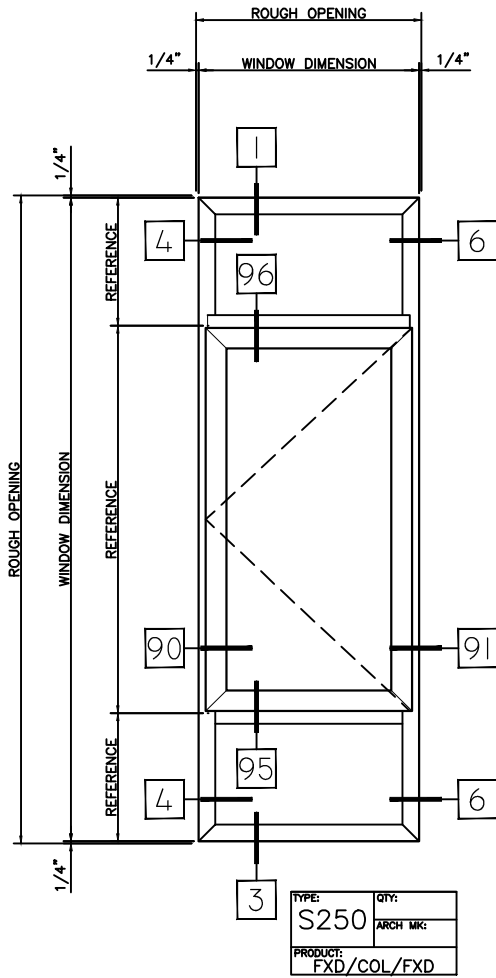

HALF SCALE DETAILS

# WINTECH

P.O. BOX 480  
MONETT, MO 65708-0480

P: 417-235-7821  
F: 417-737-7140  
www.wintechinc.com

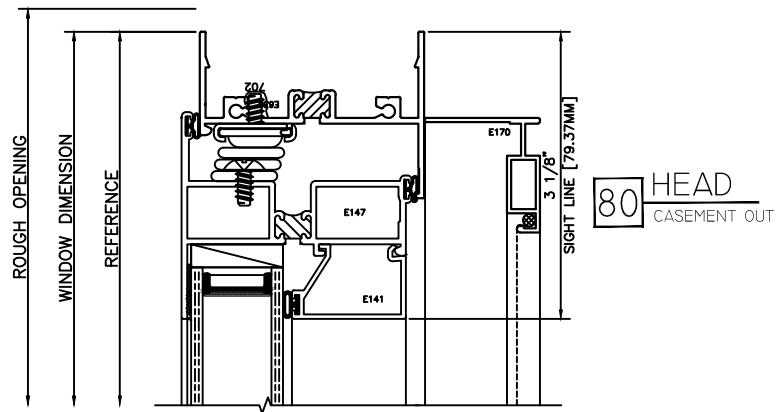

**80** HEAD  
CASEMENT OUT

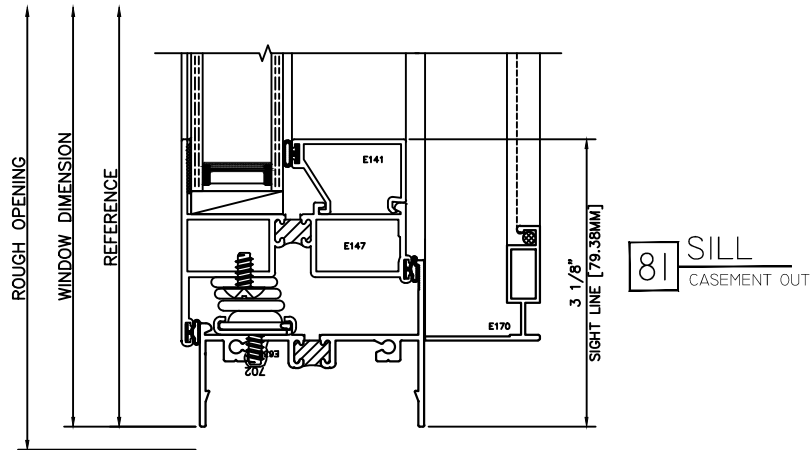

**81** SILL  
CASEMENT OUT

**82** JAMB  
COL-HINGE RAIL

**83** JAMB  
COL-LOCK RAIL

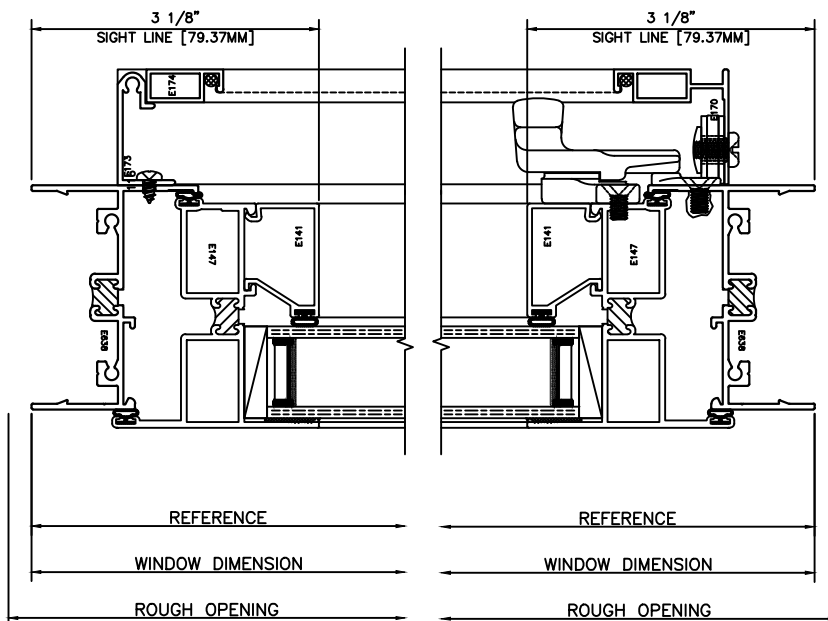

HALF SCALE DETAILS

84 JAMB  
COR-LOCK RAIL

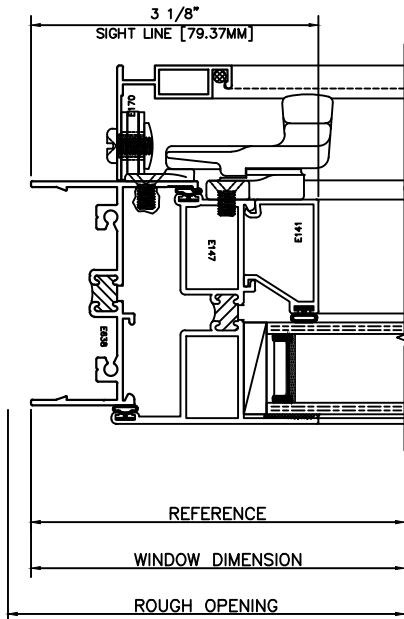

85 JAMB  
COR-HINGE RAIL

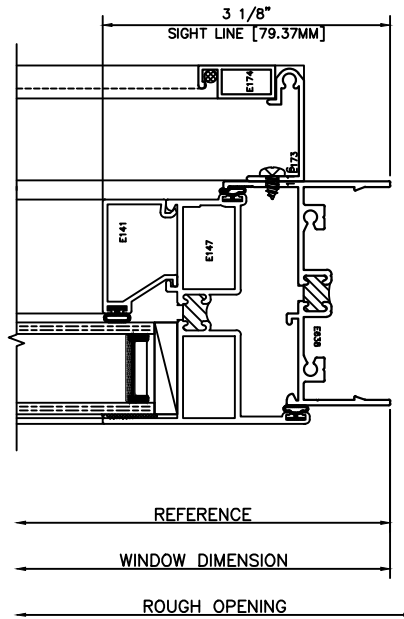

86 JAMB  
COR-LOCK RAIL

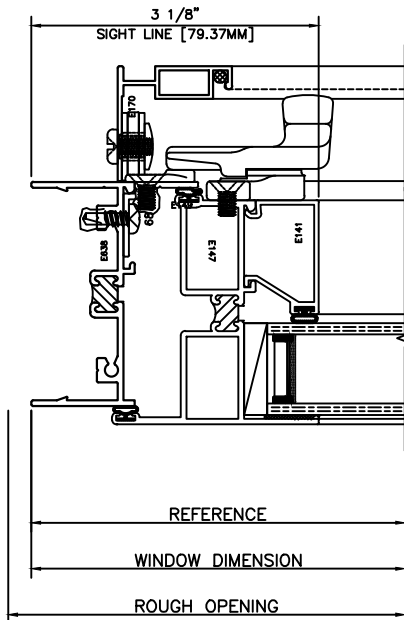

87 JAMB  
COR-HINGE RAIL

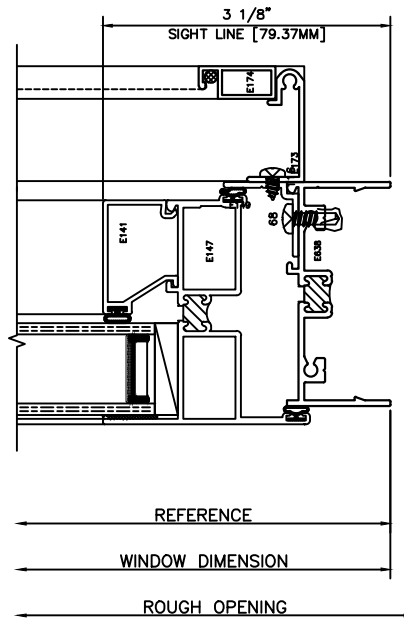

HALF SCALE DETAILS



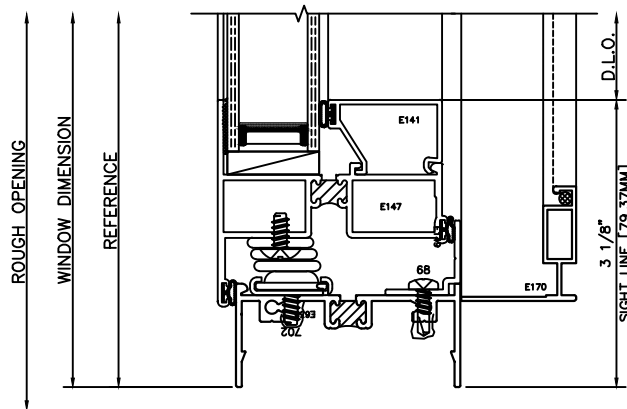
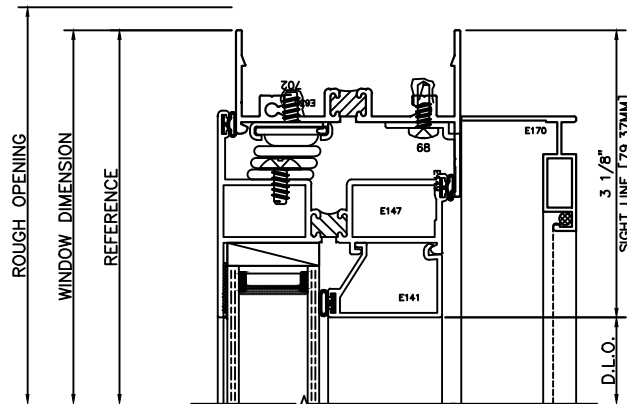

90 JAMB COL-HINGE RAIL

91 JAMB COL-LOCK RAIL

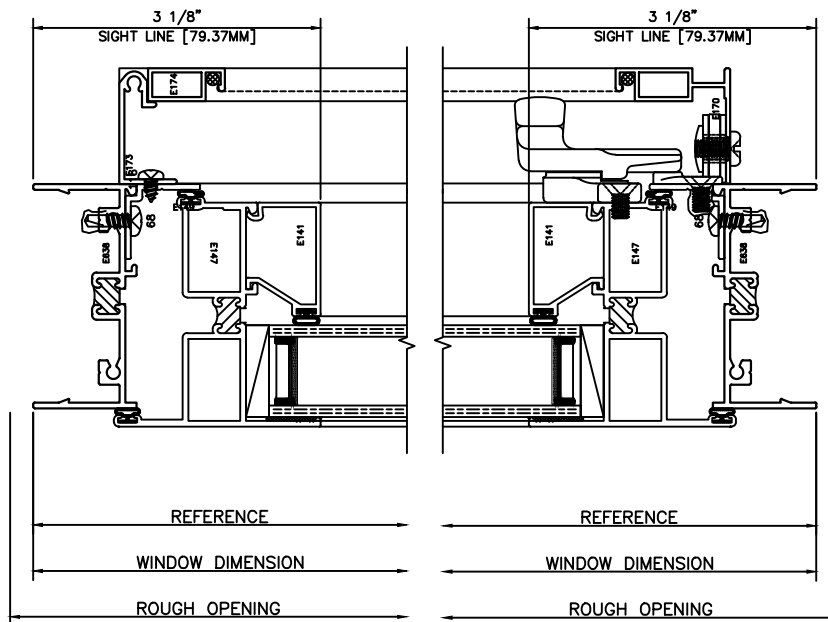

HALF SCALE DETAILS

92 MTG RAIL  
COL LOCK RAIL-FXD

93 MTG RAIL  
FXD-COR LOCK RAIL

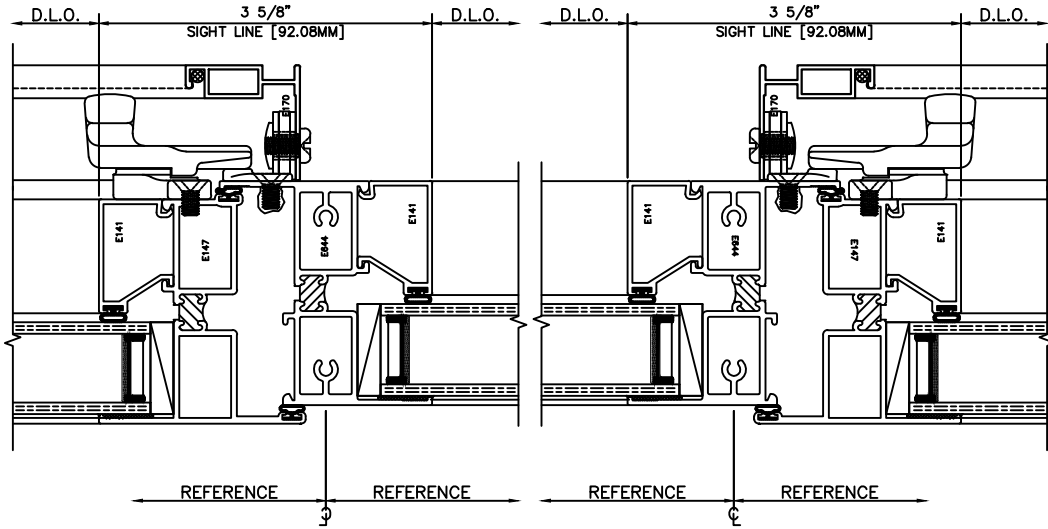

94 MTG RAIL  
COL-COR  
LOCK RAIL

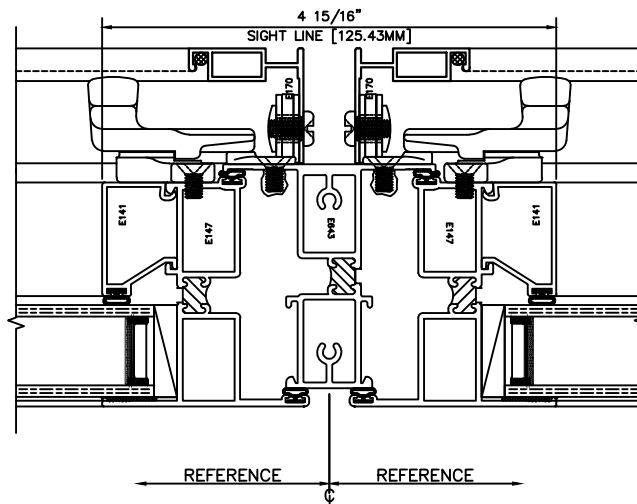

HALF SCALE DETAILS

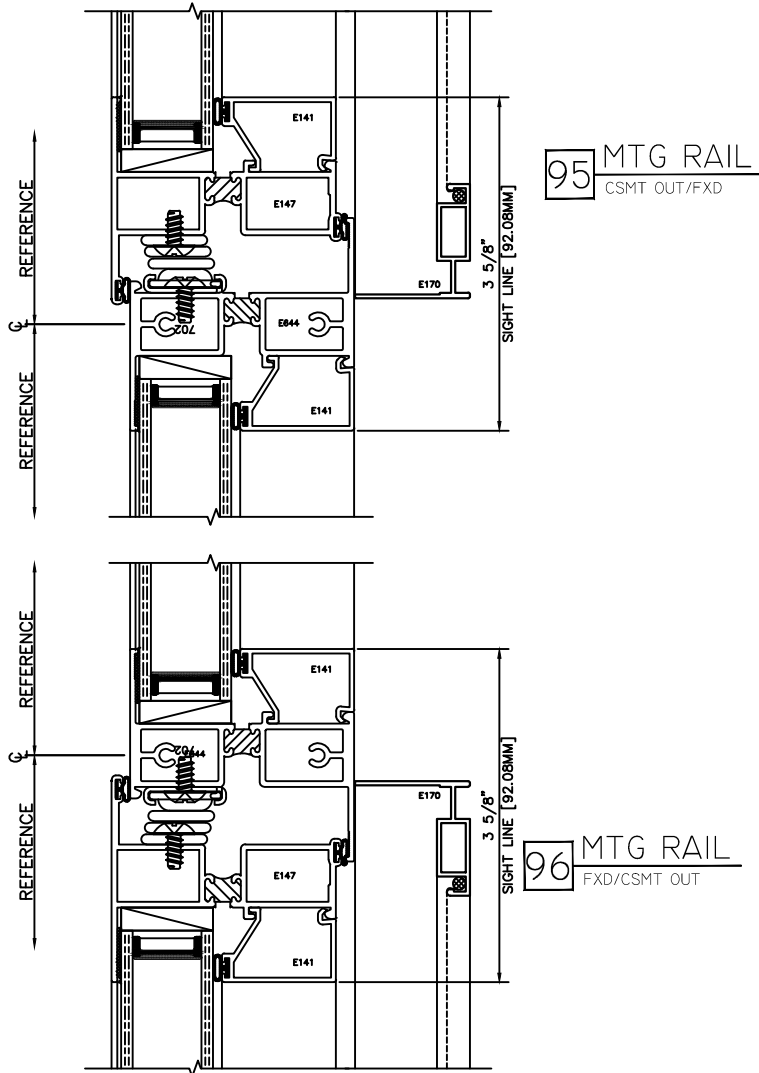

## 97 STACK JAMB COL. LOCK RAIL-FIXED

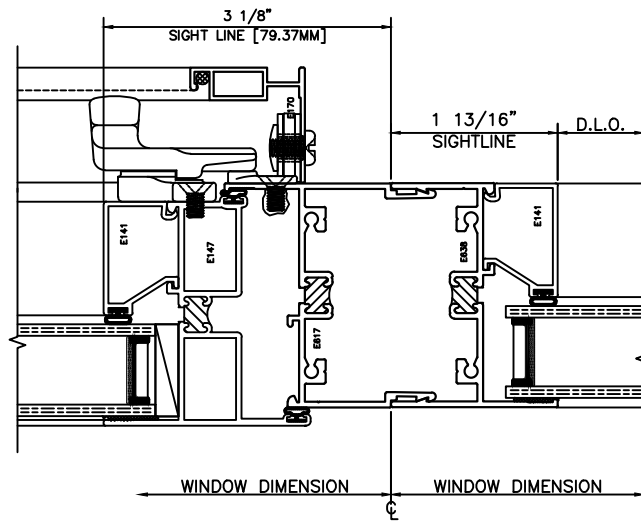

## 98 STACK JAMB FIXED-COR LOCK RAIL

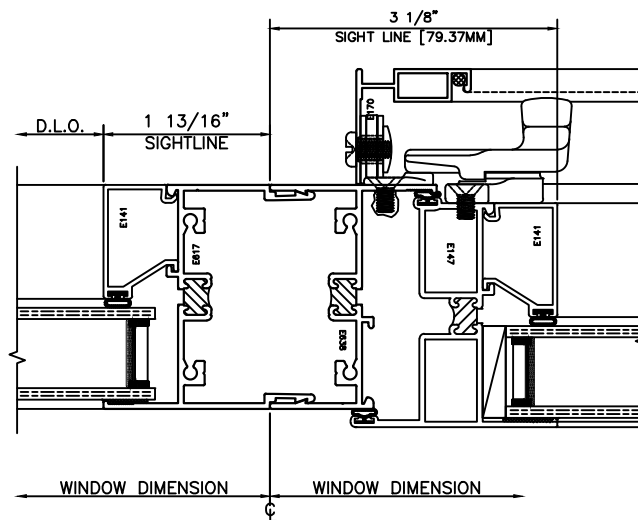

HALF SCALE DETAILS